

# LOW-COST, LOW-POWER AND LONG-RANGE IMAGE SENSOR FOR VISUAL SURVEILLANCE

C. PHAM  
UNIVERSITY OF PAU, FRANCE

SMARTOBJECTS'2016  
NEW-YORK CITY, USA,  
OCTOBER 3RD, 2016



PROF. CONGDUC PHAM  
[HTTP://WWW.UNIV-PAU.FR/~CPHAM](http://www.univ-pau.fr/~cpham)  
UNIVERSITÉ DE PAU, FRANCE



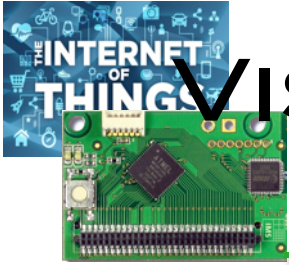

# VISUAL DATA FOR SITUATION-AWARENESS

**Wireless Sensor Networks**

**COVERAGE**  
COVER-SET SELECTION

Multihop routing  
& IEEE 802.15.4

**Image sensors**

**Activity-scheduling**

**MAC layer for low latency**  
How to synchronize on multi-hop scenario

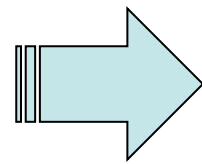
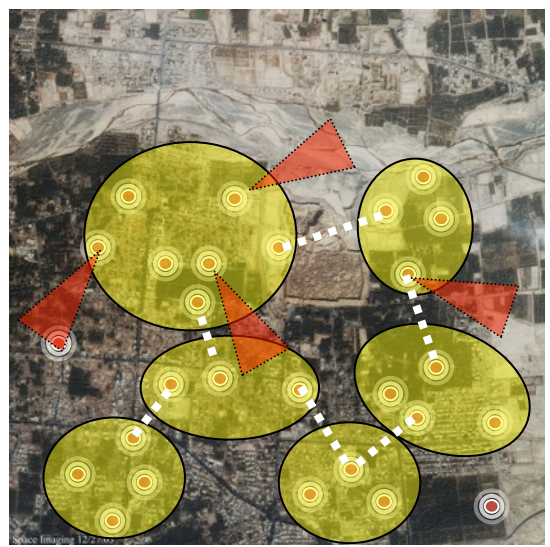

**COLLECT VISUAL DATA FOR SITUATION AWARENESS,  
SAFETY/RESCUE OPERATIONS**

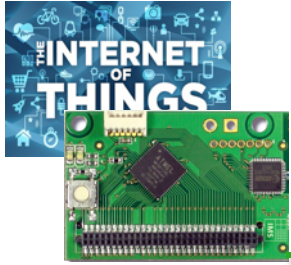

# IOT FOR DEVELOPING COUNTRIES



[www.waziup.eu](http://www.waziup.eu)

5 EU partners

7 African partners



Irrigation & Agriculture



Livestock farming



Fish farming & aquaculture



Storage & logistic



Health



Water quality

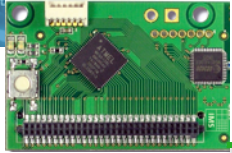

# RURAL SENSING: MORE PRAGMATIC?

Moisture/  
Temperature  
of storage  
areas



10-15kms



Pay subscription  
Limitation of coverage  
High energy consumption

Technology	2G	3G	LAN
Range (I=Indoor, O=Outdoor)	N/A	N/A	O: 300m I: 30m
Tx current consumption	200-500mA	500-1000mA	100-300mA
Standby current	2.3mA	3.5mA	NC

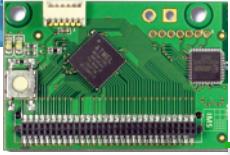

# LOW-POWER AND LONG-RANGE?

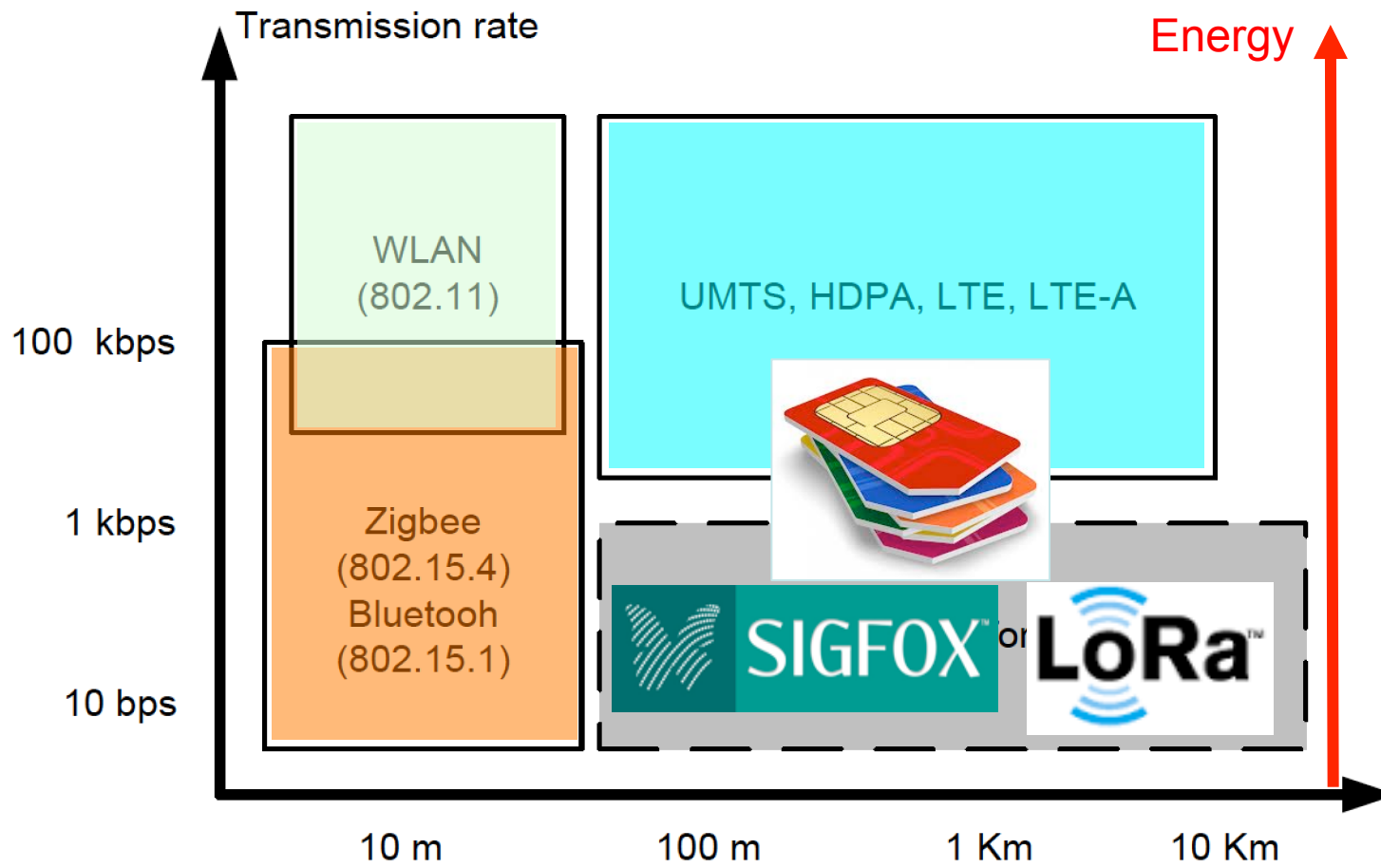

Enhanced from M. Dohler "M2M in SmartCities"

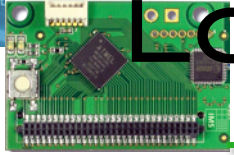

# LOW POWER WAN (LPWAN) ?

Tables from Semtech

Technology	2G	3G	LAN	ZigBee	Lo Power WAN
Range (I=Indoor, O=Outdoor)	N/A	N/A	O: 300m I: 30m	O: 90m I: 30m	Same as 2G/3G
Tx current consumption	200-500mA	500-1000mA	100-300mA	18mA	18mA
Standby current	2.3mA	3.5mA	NC	0.003mA	0.001mA
Energy harvesting (solar, other)	No	No	No	Possible	Possible
Battery 2000mAh (LR6 battery)	4-8 hours(com) 36 days(idle)	2-4 hours(com) X hours(idle)	50 hours(com) X hours(idle)	60hours (com)	120 hours(com) 10 year(idle)
Module Revenue Annually	12 \$	20 \$	4 \$	\$3	3 \$

Autonomy GSM with 2000mAh -



Autonomy LP WAN with 2000mAh -



Example for energy meter



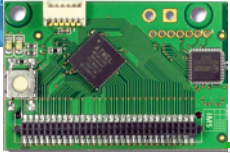
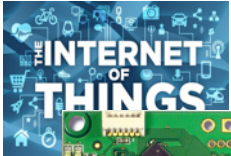

# LPWAN ARCHITECTURE

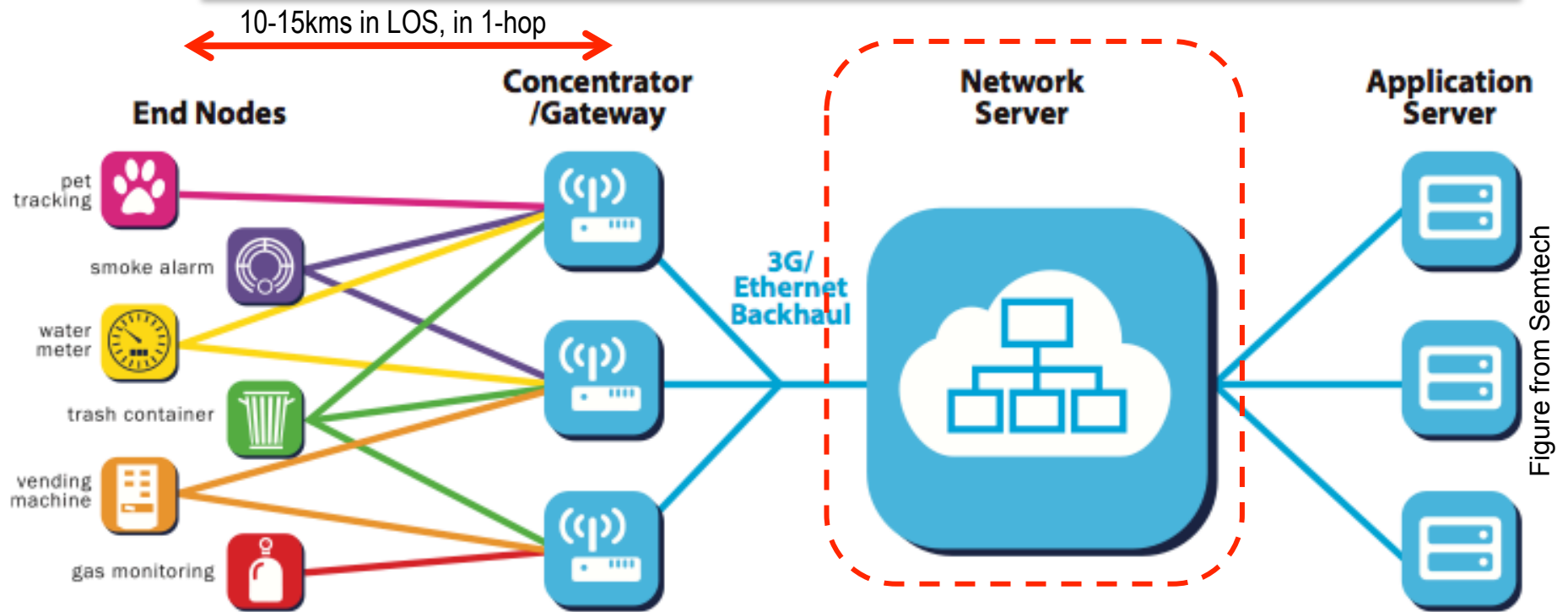
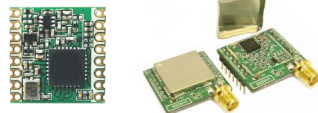

Figure from Semtech



No subscription  
 Deploy own network  
 Low energy consumption

Add LoRa radio module to your preferred dev platform



Install a LoRa gateway and start collecting data



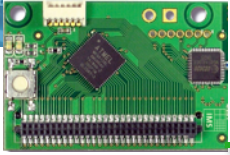

# IOT BECOMES REALITY!

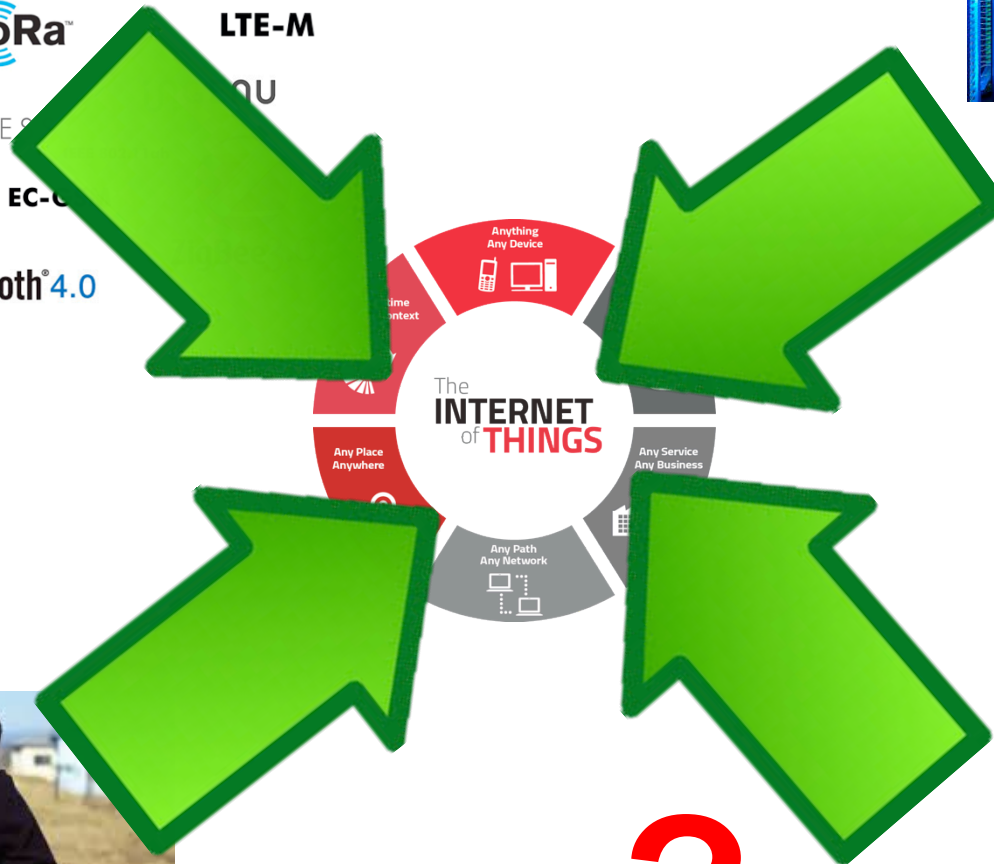



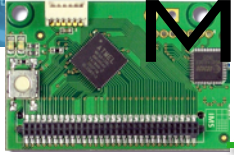

# MOTIVATIONS & OBJECTIVES

---

- ❑ **Simplicity: no specialized hardware**
  - ❑ Image encoding with the host  $\mu$ C (no additional nor dedicated  $\mu$ C)
  - ❑ Off-the-shelf components
  - ❑ Quick appropriation (hardware and software) and high availability
  - ❑ Maximum flexibility and simplicity in programming and design
  - ❑ “out-of-the-box” deployment (no multi-hop)
- ❑ **... but still efficient**
  - ❑ Fast encoding
  - ❑ Packet loss-tolerant bit stream
  - ❑ Low-power to run on battery for months

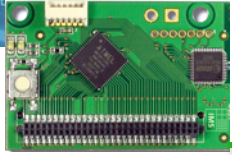

# THE DIY ECOSYSTEM

- ❑ Many powerful microcontroller boards available
- ❑ Do-It-Yourself approach with off-the-shelves components provides high flexibility/sustainability

Arduino Pro Mini

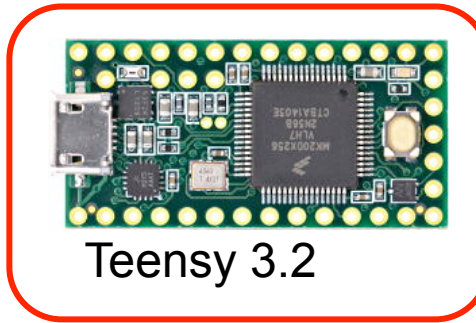
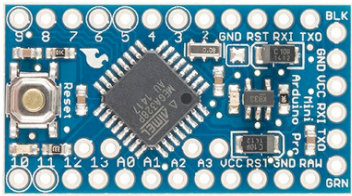

Teensy 3.2

LinkIt Smart 7688 Duo

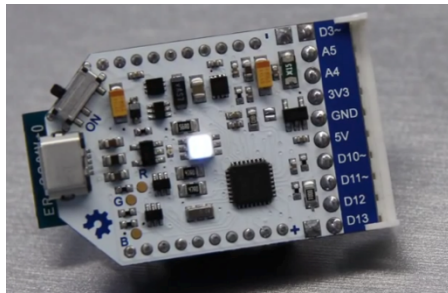
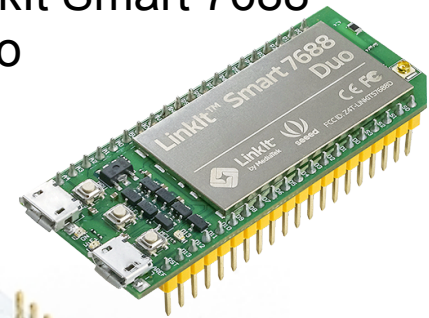

TheAirboard on kickstarter

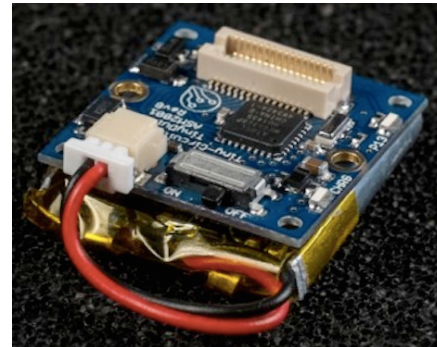

Tinyduino

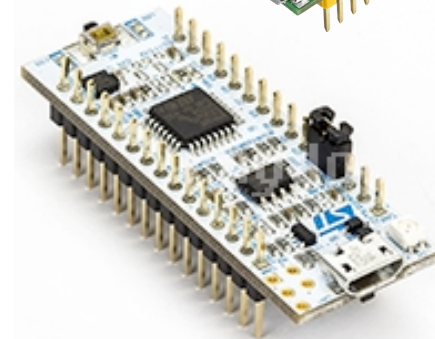

STM32 Nucleo-32

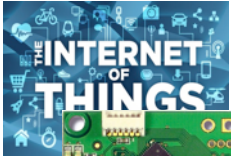

# TEENSY + UCAMII 128X128 8BPP RAW IMAGES

\$15

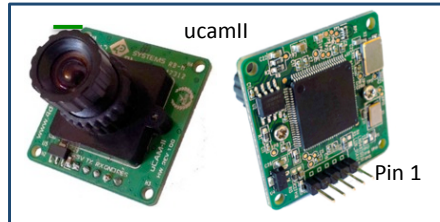
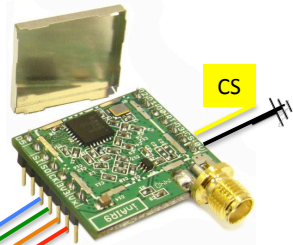

\$35

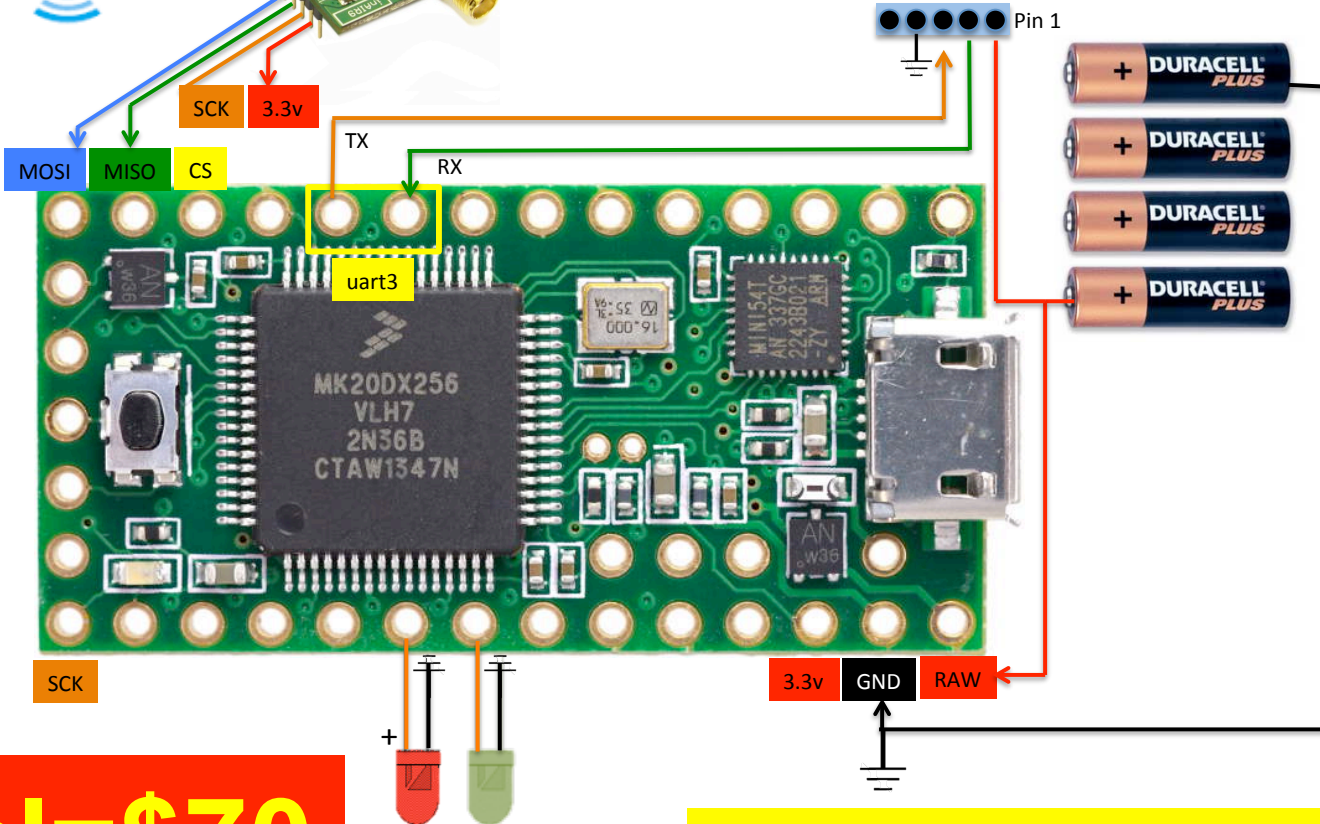

\$20

**Total=\$70**

Teensy32, MK20DX256 Cortex-M4  
at nominal 72MHz, 64KB SRAM

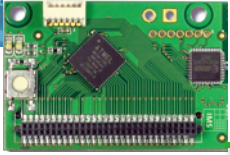

# OUTDOOR DEPLOYMENT

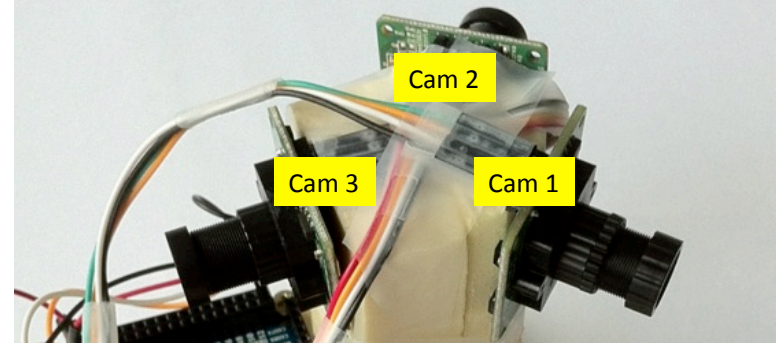
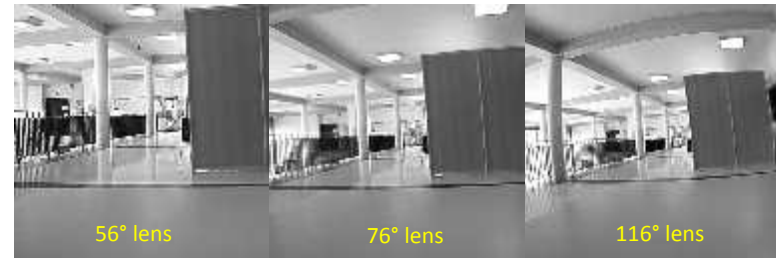
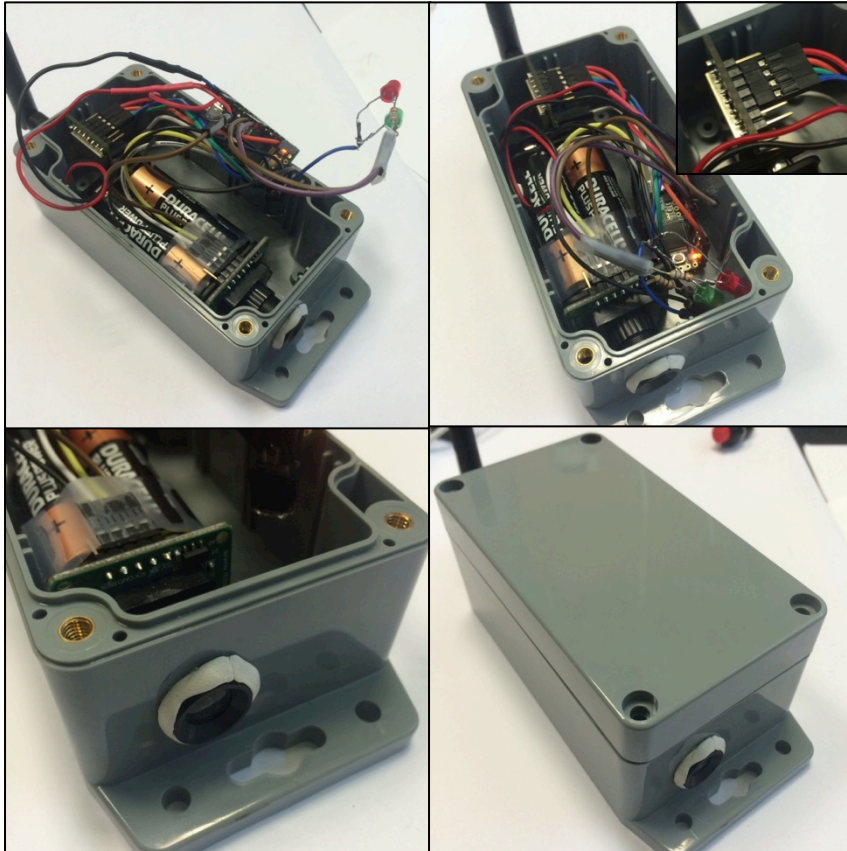

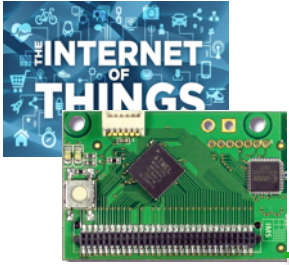

# IMAGE ENCODING

ADJUSTABLE  
IMAGE QUALITY  
FACTOR Q

Scientific cooperation with V. Lecuire from  
CRAN laboratory for the optimized image  
encoding algorithm

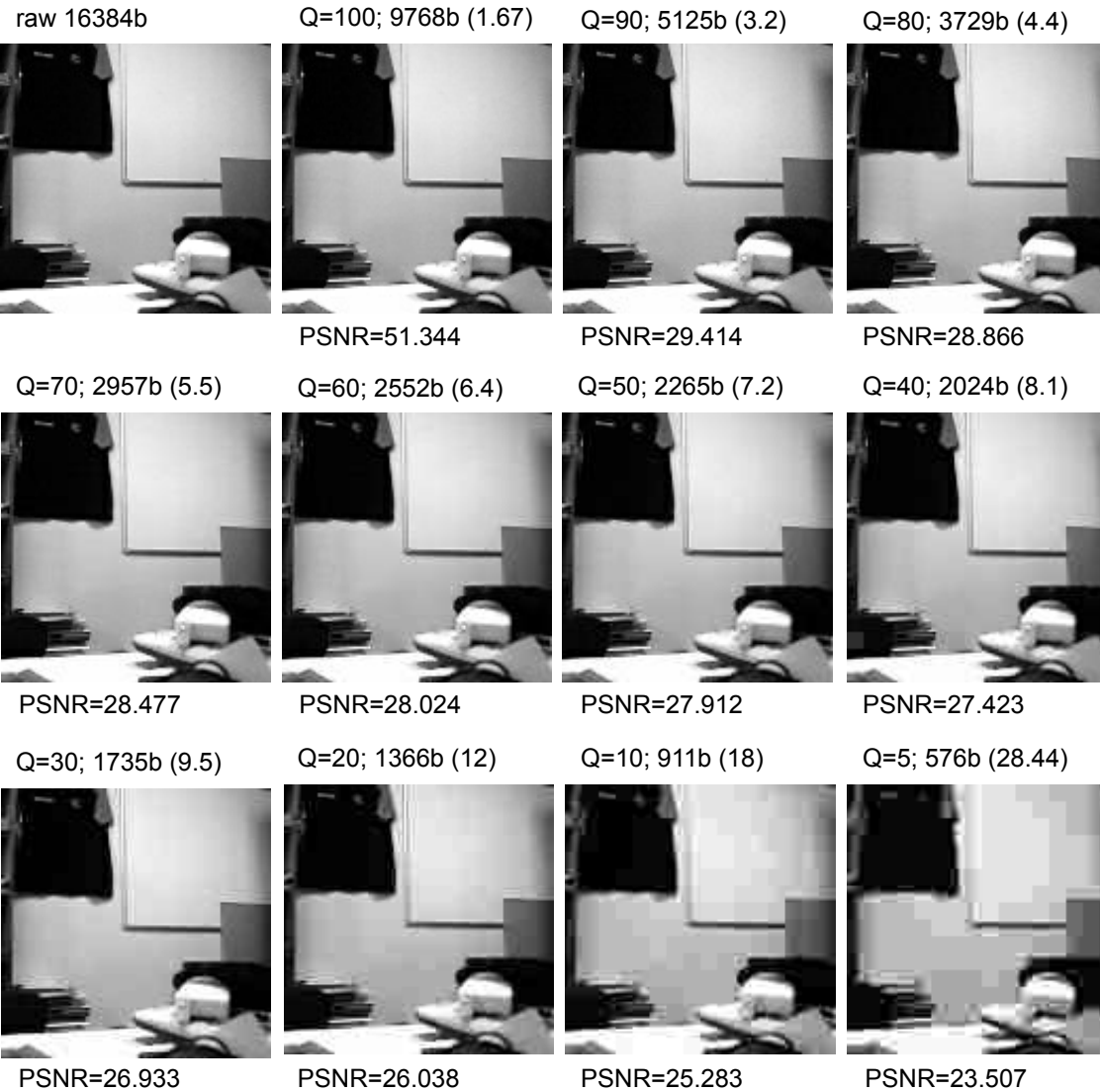



# PACKET LOSS-TOLERANT BIT STREAM, ANY RECEPTION ORDER

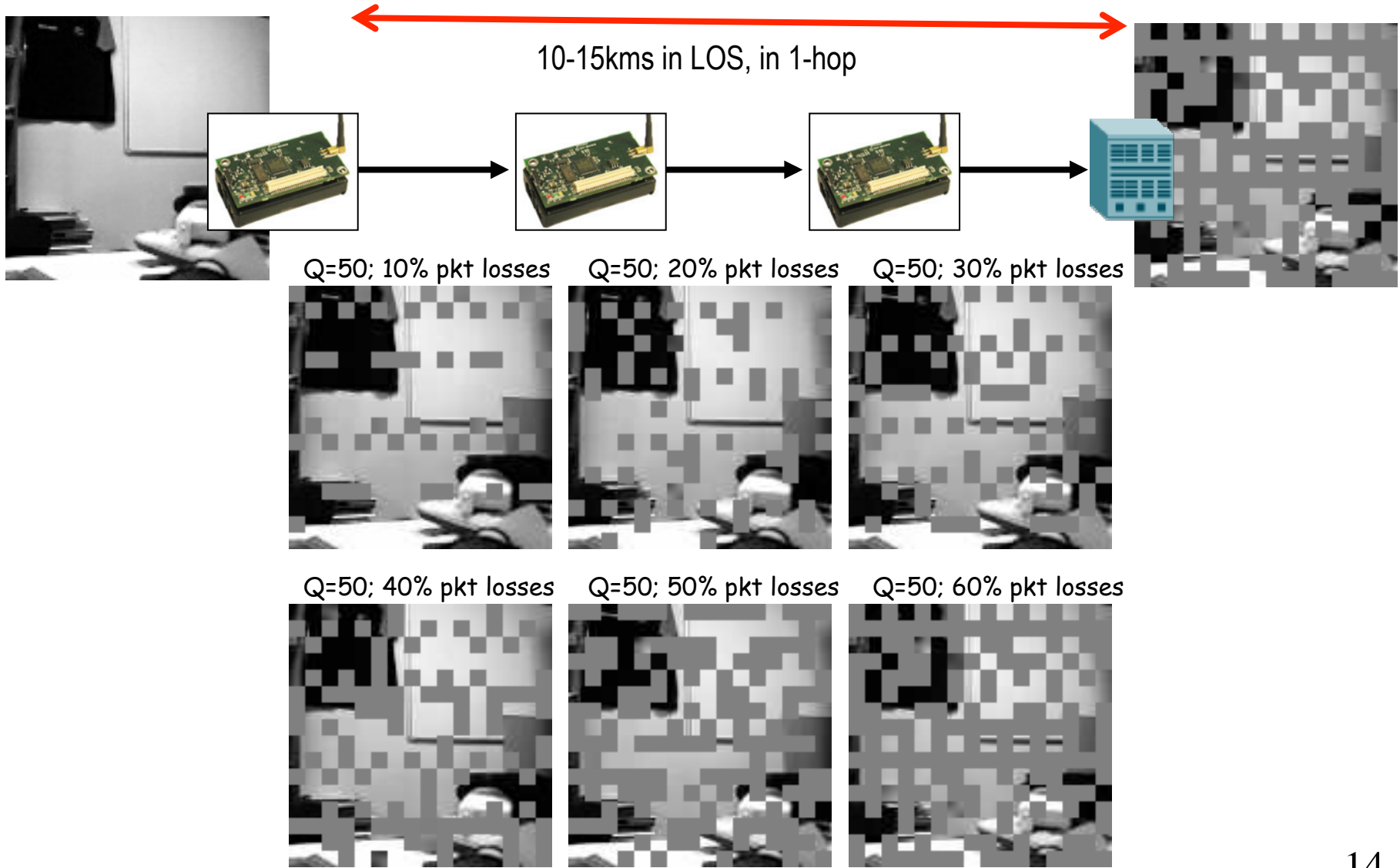

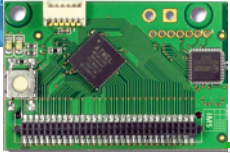

# LOW-COST GATEWAY

Moisture/  
Temperature  
of storage  
areas



10-15kms

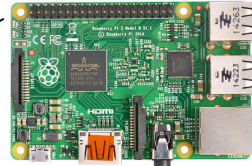

We can use all model of Raspberry. The most important usefull feature is the Ethernet interface for easy Internet connection. Then WiFi and Bluetooth can be added with USB dongles. **RPI3 provides built-in Ethernet, WiFi and Bluetooth!**



**Less than 50€**



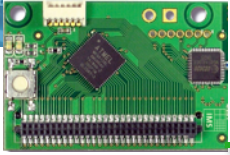

# OUT-OF-THE-BOX !

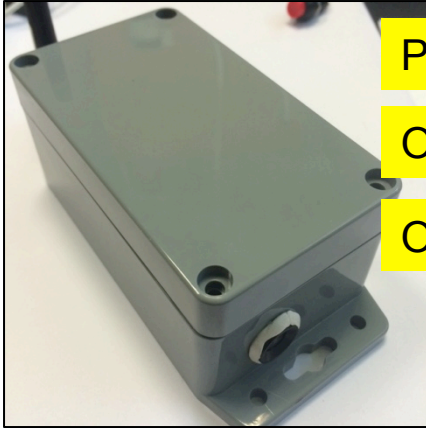

Periodic

On-demand

On event

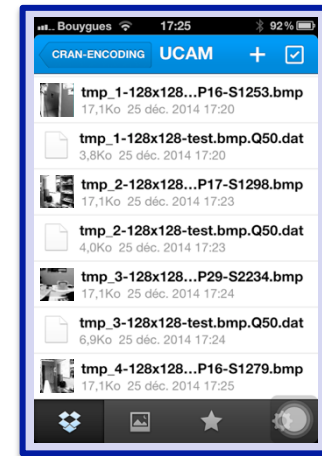
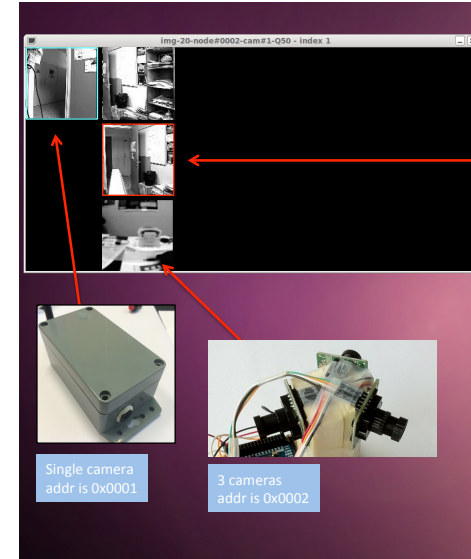



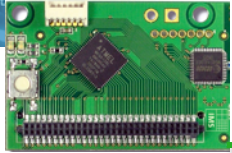

# VERSATILE GATEWAY



Can push raw data on clouds

Can locally decode & push image on clouds

Can locally decode & store

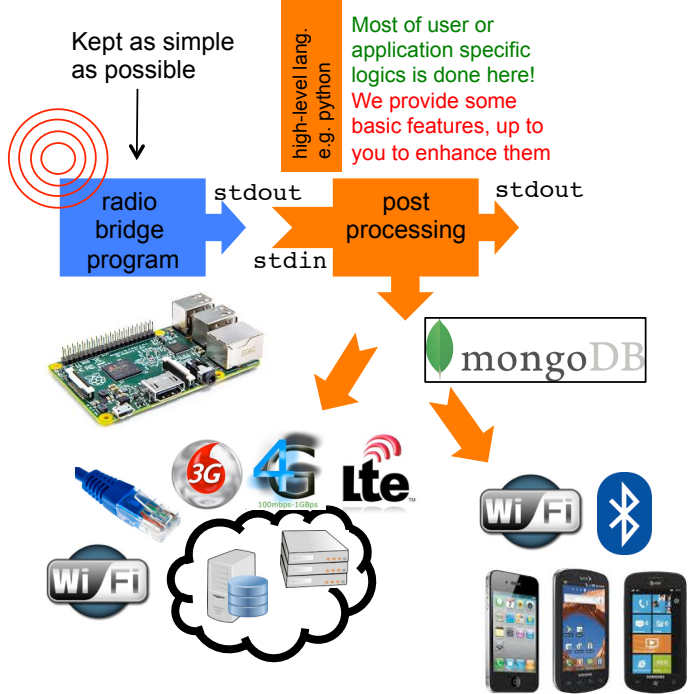
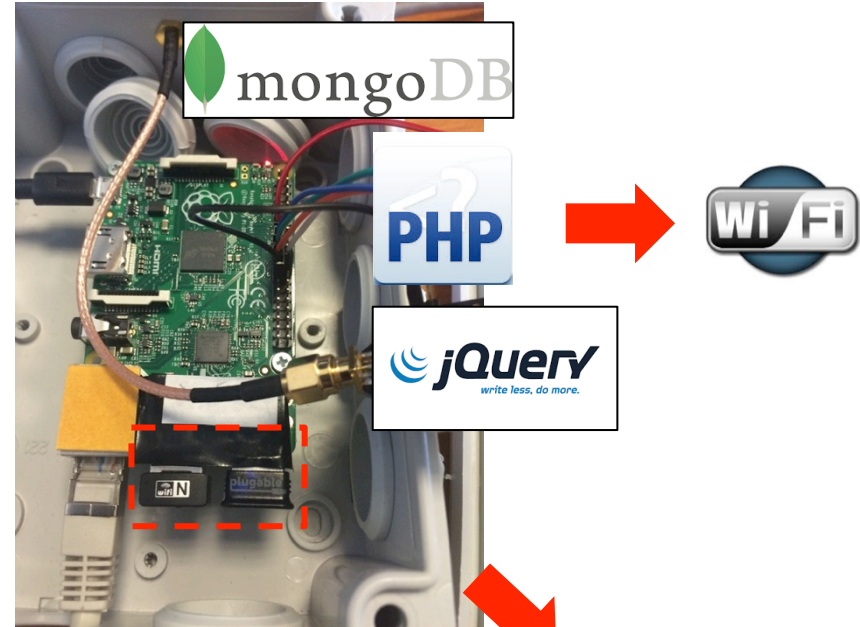

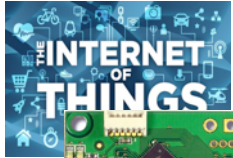

# IMAGE ENCODING PERFORMANCES

Quality Factor Q	96MHz		72MHz		48MHz		24MHz		MSS=240	
	encode	packetiza	encode	packetiza	encode	packetiza	encode	packetiza	N	S
							tion time		number of packets	size in bytes (compression ratio)
100								813	47	9982 (1.64)
90								322	23	5090 (3.21)
80								218	16	3595 (4.55)
70								178	13	2842 (5.76)
60								162	11	2461 (6.65)
50								150	10	2129 (7.69)
40								139	9	1898 (8.63)
30								127	7	1608 (10.19)
20	224	33	260	44	345	64	637	127	6	1279 (12.81)
10	223	26	260	31	345	50	636	99	4	824 (19.88)
5	223	23	259	31	344	45	635	89	3	503 (32.57)



- ❑ Capturing an image and encoding it roughly take 2.3s
  - ❑ Time to sync & config ucam is about 400ms
  - ❑ Time to read raw image data from ucam is 1512ms
  - ❑ Time for encoding and packetization is about 300ms

Teensy 3.2  
sync cam, config cam,  
read, encode, packetization

Global sync, config, read, encode  
consumption is about 1.254 J  
about 2.3s

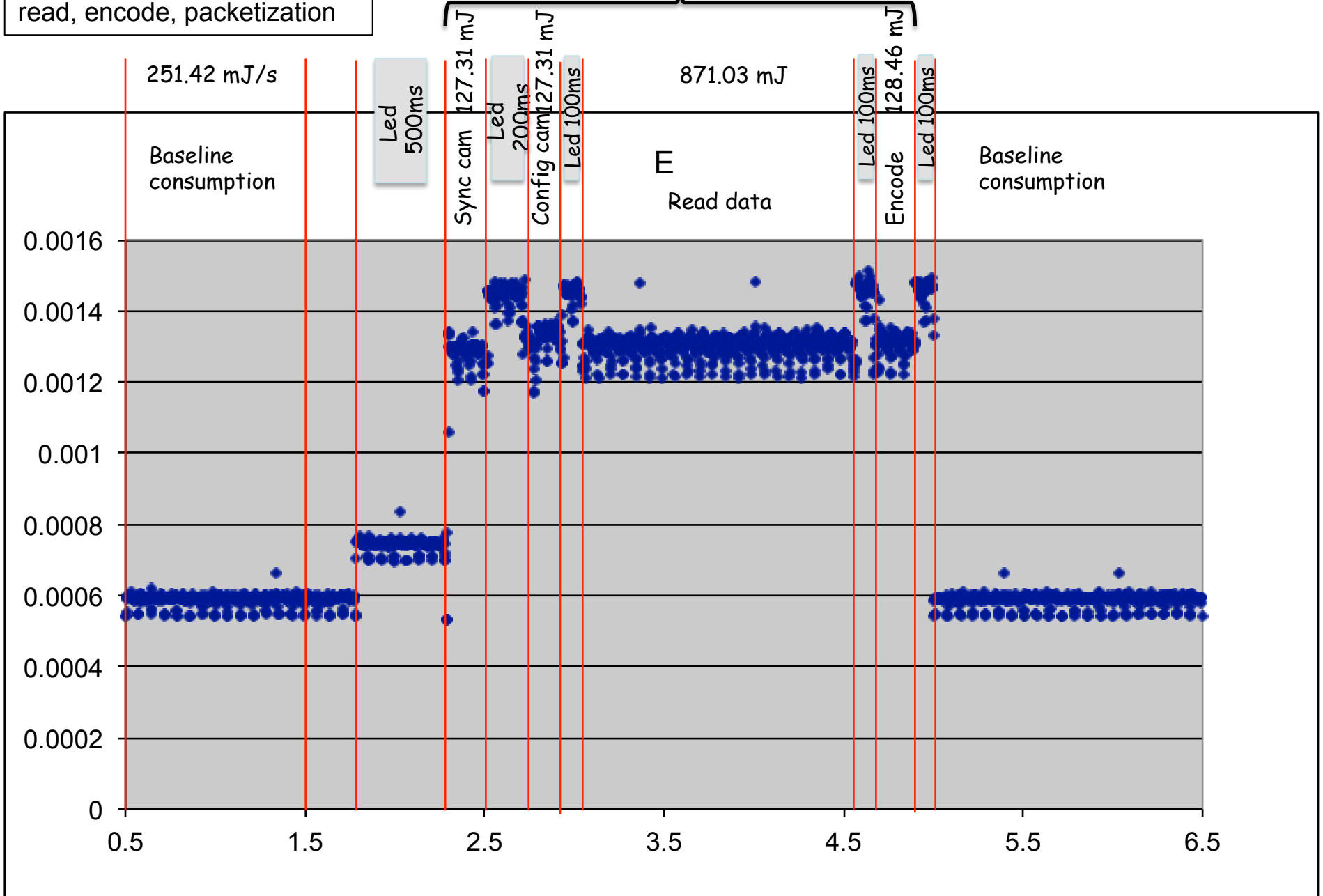

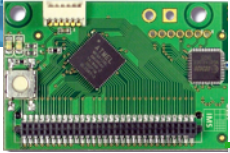

# POWER CONSUMPTION

	baseline (mJ/s)	baseline, hibernate (mJ/s)	read (mJ)	encode (mJ)	Read+encode (mJ)
96MHz	251.42	0.834	871.03	128.46	999.49
72MHz	219.54	0.834	834.97	143.58	978.55
48MHz	211.19	0.834	813.30	185.58	998.88
24MHz	160.95	0.834	719.09	302.48	1021.57

- ❑ Using the nominal 72MHz mode minimizes consumption
- ❑ Hibernate mode when idle consumes about 167uA
- ❑ When transmitting the board consumes about 68mA
- ❑ Assuming
  - ❑ 1 image/hour (2s)
  - ❑ Image encoding with Q=10 (300ms)
  - ❑ Transmission of 4 packets (8s)
- ❑ Then can run for 268 days on 4 AA batteries



# UNLICENSED SUB-GHZ SPECTRUM CONSTRAINTS

- ❑ It is shared medium so long-range transmission in dense environments can create lots of interference!
- ❑ Activity time is constrained from 0.1% to 1% duty-cycle depending on frequency: 3.6s to 36s/hour
- ❑ Time-on-Air (ToA) is the constraint

Band	Edge Frequencies		Field / Power	Spectrum Access	Band Width
	Fc-	Fc+			
g(Note 7)	865 MHz	868 MHz	+6.2 dBm /100 kHz	1 % or LBT AFA	3 MHz
g(Note 7)	865 MHz	870 MHz	-0.8 dBm / 100 kHz	0.1% or LBT AFA	5 MHz
g1	868 MHz	868.6	14 dBm	1 % or LBT AFA	600 kHz
g2	868.7 MHz	869.2 MHz	14 dBm	0.1% or LBT AFA	500 kHz
g3	869.4 MHz	869.65 MHz	27 dBm	10 % or LBT AFA	250 kHz
g4	869.7 MHz	870 MHz	7 dBm	No requirement	300 kHz
g4	869.7 MHz	870 MHz	14 dBm	1 % or LBT AFA	300 kHz

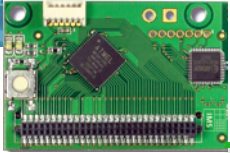

# TIME-ON-AIR OF IMAGE TRANSMISSIONS

LoRa mode	BW	CR	SF	time on air in second for payload size of					
				5 bytes	55 bytes	105 bytes	155 Bytes	205 Bytes	255 Bytes
1	125	4/5	12	0.95846	2.59686	4.23526	5.87366	7.51206	9.15046
2	250	4/5	12	0.47923	1.21651	1.87187	2.52723	3.26451	3.91987
3	125	4/5	10	0.28058	0.69018	1.09978	1.50938	1.91898	2.32858
4	500	4/5	12	0.23962	0.60826	0.93594	1.26362	1.63226	1.95994
5	250	4/5	10	0.14029	0.34509	0.54989	0.75469	0.95949	1.16429
6	500	4/5	11	0.11981	0.30413	0.50893	0.69325	0.87757	1.06189
7	250	4/5	9	0.07014	0.18278	0.29542	0.40806	0.5207	0.63334
8	500	4/5	9	0.03507	0.09139	0.14771	0.20403	0.26035	0.31667
9	500	4/5	8	0.01754	0.05082	0.08154	0.11482	0.14554	0.17882
10	500	4/5	7	0.00877	0.02797	0.04589	0.06381	0.08301	0.10093

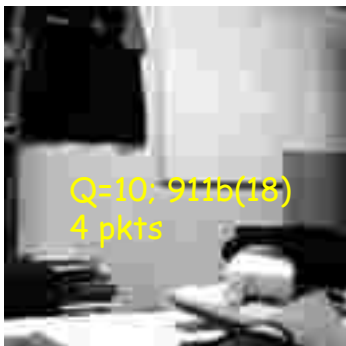

Image encoded at low quality: 16384b down to 911b (ratio 18).

Will generate 4 pkts using 250 max payload



$$4 * 9.15 = 36.6s$$

$$4 * 1.96 = 7.84s$$

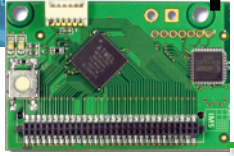

# THINGS WE ARE DOING FOR RESEARCH

---

- ❑ To leverage the « single » connection gateway approach
  - ❑ Smarter radio channel access mechanism
- ❑ To handle larger amount of data (image)
  - ❑ Quality of Service mechanism
  - ❑ Activity sharing mechanism
- ❑ The ad-hoc LoRa framework can be used to set-up your own LoRa test-bed for implementing advanced mechanisms

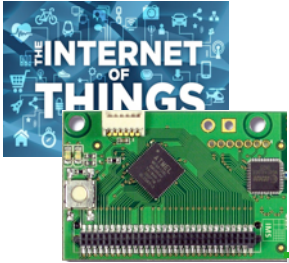

# TEST ADVANCED CHANNEL ACCESS

- ❑ Implement & test channel access methods
  - ❑ SIFS=xCAD; DIFS=3SIFS; set x with /@CADONx#
  - ❑ Use background traffic generator devices
  - ❑ /@T2000# or /@TR5000#

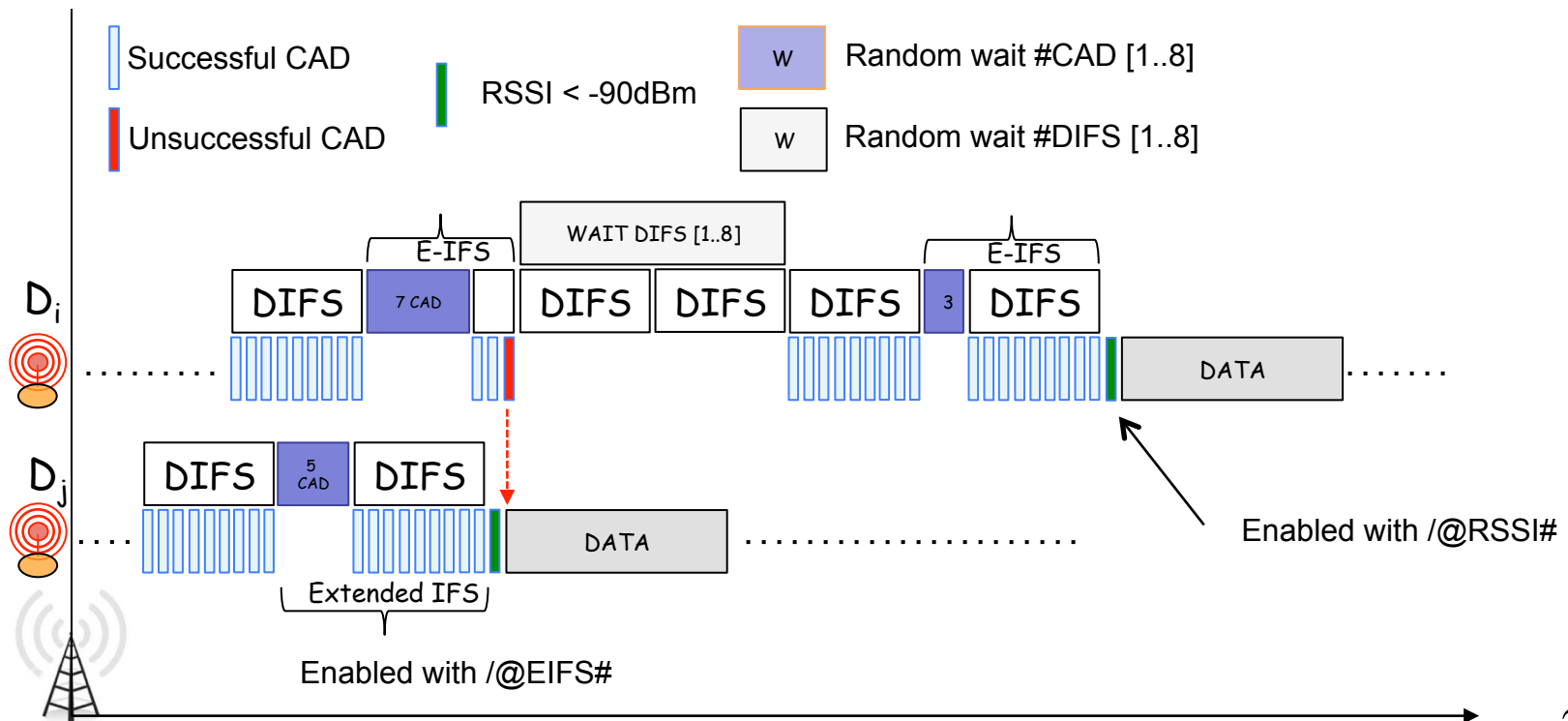



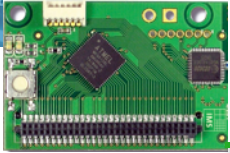

# LONG-RANGE ACTIVITY SHARING (LAS)

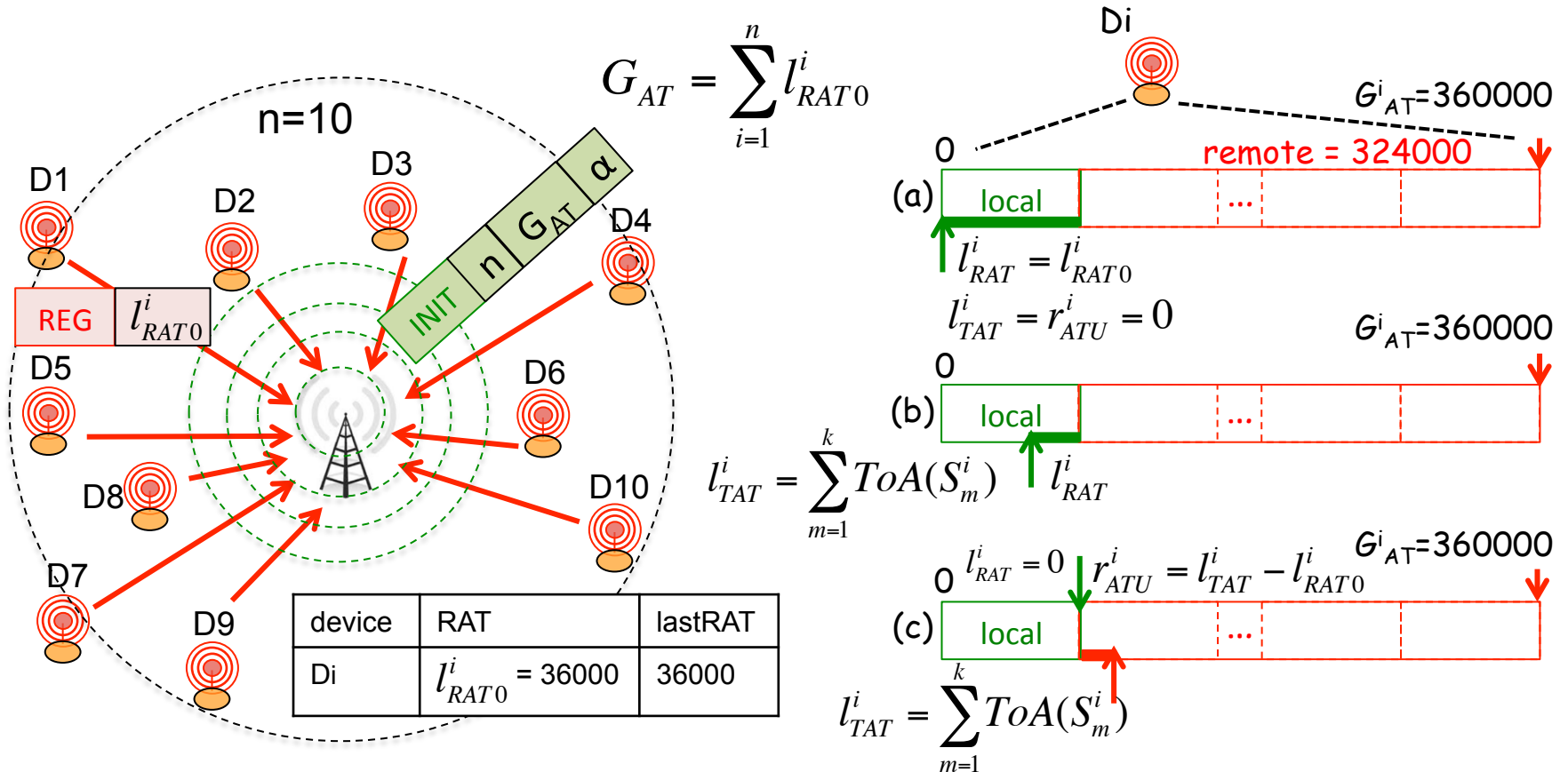

A device can transmit more if needed, provided that other devices will decrease their radio activity time accordingly.

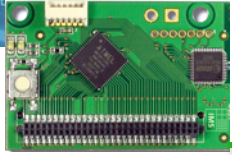

# CONCLUSIONS

---

- ❑ Low-cost, long-range image sensor with efficient packet loss-tolerant encoding
- ❑ Low-power: about 115mA when capturing and encoding (2s)
- ❑ Runs out-of-the box for periodic image or surveillance tasks based on image change detection
- ❑ A complete image cycle is about 10s
- ❑ DIY with off-the-shelves components for maximum product availability and technology appropriation/customization



Thanks.  
**Let's keep in touch**



Accompagnateur de croissance TIC

**Carine VAVASSEUR**

*Communication & Event Manager*

Carine.vavasseur@cticdakar.com

www.cticdakar.com  
contact@cticdakar.com



facebook.com/waziupIoT



twitter.com/waziupIoT



linkedin.com/groups/8156933



github.com/waziup